

OVA

Non see-through transfer and extract air grille, installed as protruding unit

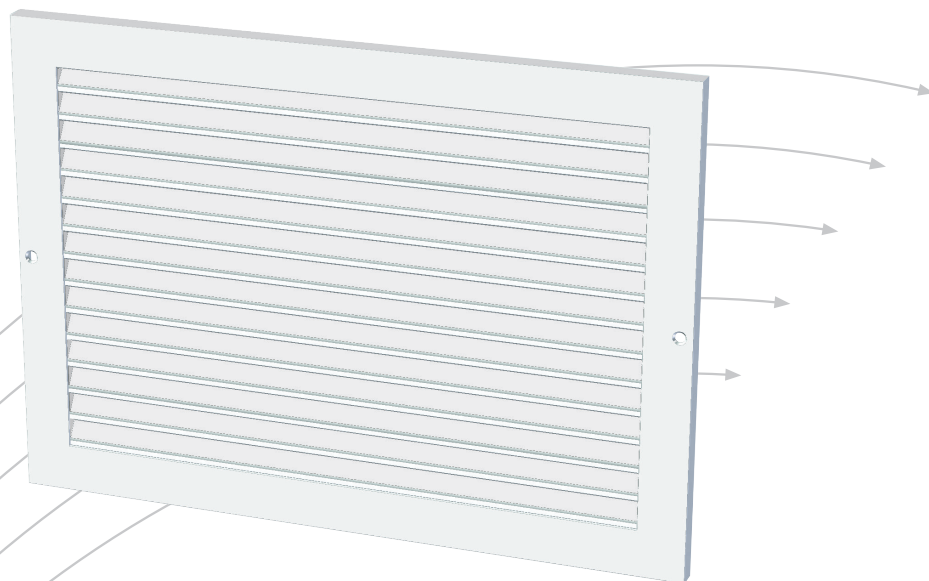

- Non see-through
- Installation friendly

TROX[®] TECHNIK

 **Auranor**

TROX Auranor Norge AS

PO Box 100
NO-2712 Brandbu

Telephone +47 61 31 35 00

Fax +47 61 31 35 10

E-mail firmapost@auranor.no

www.trox.no

OVA

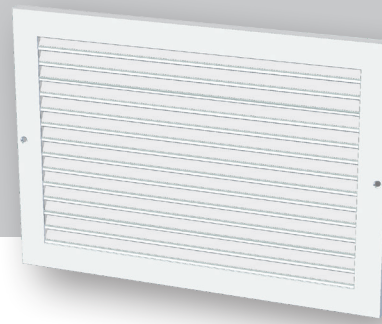

APPLICATION

OVA is designed for use as a transfer and extract air unit. The grille is non see-through, and does not require an accurately dimensioned groove.

DESIGN

OVA consist of a frame and fixed blades. Pre-drilled mounting holes are provided in the frame.

MATERIALS AND SURFACE COATING

The grille is made in extruded aluminium, and comes in a RAL 9003 - gloss 30 finish. Alternative colours are available on request.

QUICK SELECTION

OVA Dim.	[m ³ /h]		
	10 Pa	15 Pa	20 Pa
200-100	58	72	83
300-100	112	137	155
300-150	184	223	263
300-200	252	306	360
400-100	144	176	205
400-150	223	270	317
400-200	288	353	403
500-150	245	299	349
500-200	360	443	504
500-250	461	547	648
500-300	540	666	792
600-200	414	511	594
600-300	666	810	954
600-400	882	1062	1224

Table 1: The table shows flow rates at given pressure loss.

ORDER CODE, OVA

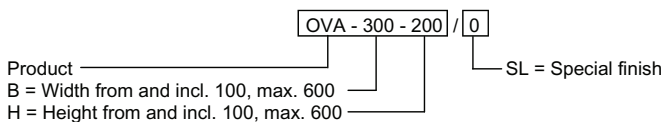

Example:
OVA-300-200 / 0
Explanation:
OVA - Width: 300, Height: 200

DIMENSIONS AND WEIGHT, OVA

Description [Nom. dim.]	BxH [mm]	Weight [kg]
200x100	202x100	0,3
300x100	304x100	0,4
300x150	304x144	0,5
300x200	304x202	0,6
400x100	400x100	0,5
400x150	400x144	0,6
400x200	400x202	0,8
500x150	500x144	0,8
500x200	500x202	1,0
500x250	500x246	1,1
500x300	500x304	1,3
600x200	600x202	1,1
600x300	600x304	1,6
600x400	600x392	1,9
600x500	600x500	2,3
600x600	600x600	2,7

Table 2

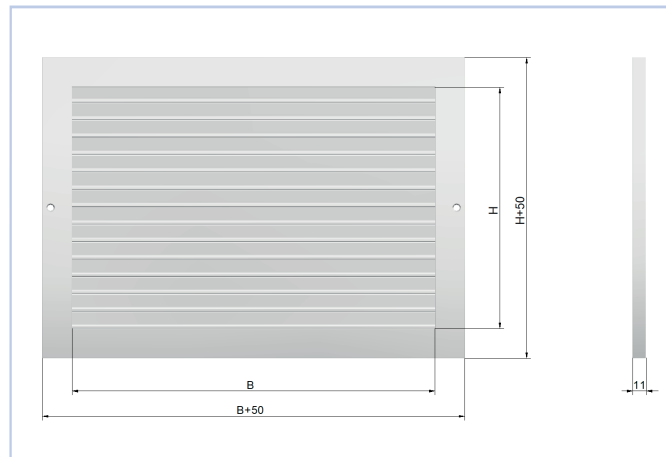

Figur 1

OVA

ACOUSTIC DATA

When used as an air extract grille, the air velocity in the connecting duct should not exceed 2 m/s in order to keep the sound pressure level below 30 dB(A).

Diagram 1 and 2 apply to extract air, ducted situation.

For transfer air situation with 2 OVA together, multiply pressure drop with 2.

The formula used to limit air volume in the duct is:

$$q_{[m^3/h]} = B_{[m]} \times H_{[m]} \times v_{[m/s]} \times 3600$$

where B and H is stated in meters [m] and v is the velocity in [m/s].

CALCULATION DIAGRAMS

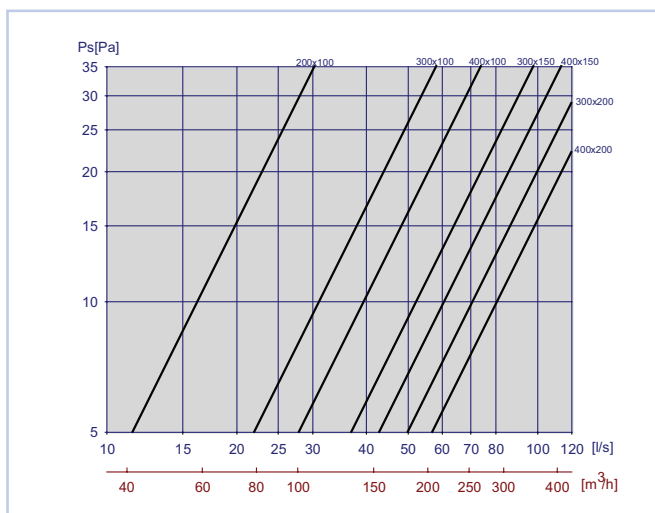

Diagram 1

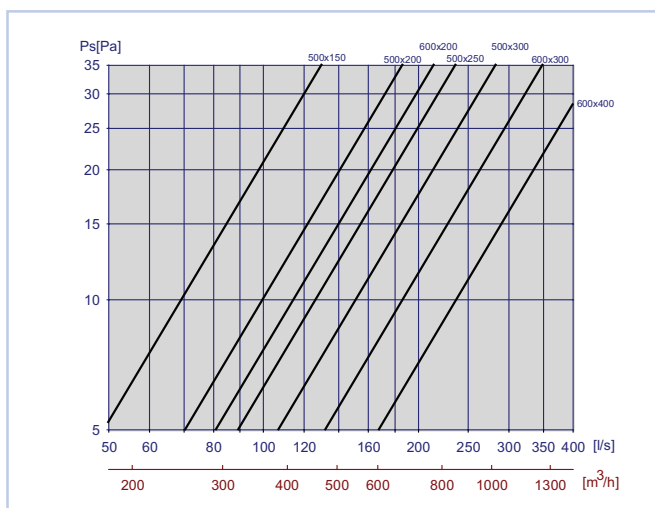

Diagram 2

OVA

INSTALLATION

OVA is mounted by means of countersunk plate screws in the grille frame. Number of screws required is included. 2 for widths up to and incl. 400, and 4 for widths of 500 and 600.

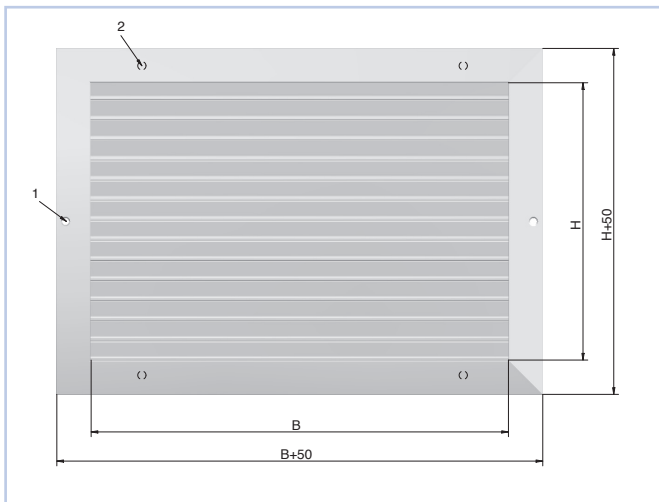

Fig. 2: Installation

1. Positioning of pre-drilled holes (2) for widths up to and incl. 400.
2. Positioning of pre-drilled holes (4) for widths of 500 and 600.

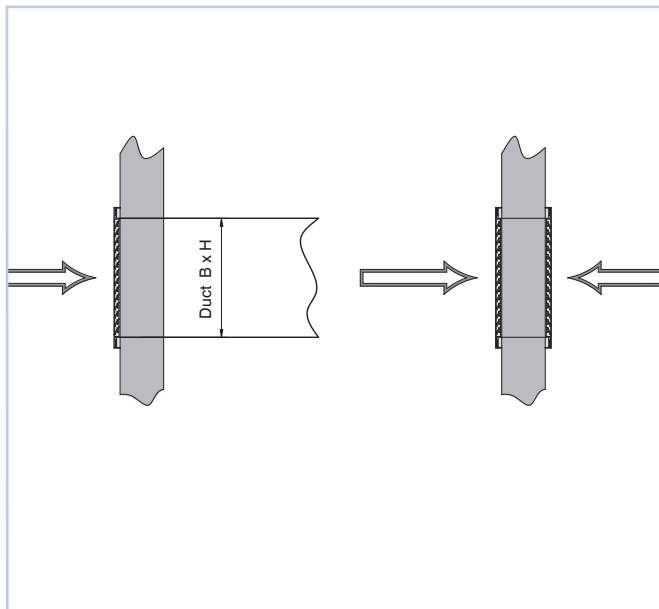

Fig. 3: Installation

Illustration to the left shows OVA connected to a duct, and illustration to the right shows 2 OVA units installed for transfer.

NB. Here the pressure drop in diagram 1 and 2 doubles.

OVA is developed and manufactured by:

TROX[®] TECHNIK
Auranor

MAINTENANCE

Can be cleaned with a damp cloth.

ENVIRONMENT

Enquiries regarding product declaration can be directed to our sales team, or information can be found at our website: www.trox.no

The company reserves the right to make amendments without prior notice.

Head Office:
TROX Auranor Norge AS, PO Box 100, NO-2712 Brandbu
Telephone: +47 61 31 35 00 Fax: +47 61 31 35 10 www.trox.no